

CS 153

Design of Operating Systems

Fall 21

Lecture 10: Paging

Instructor: Chengyu Song

Some slides modified from originals by Dave O'hallaron

Recap: Address Spaces

- **Address space:** ordered set of non-negative integer addresses: {0, 1, 2, 3 ... }
 - ◆ Addresses could be contiguous or segmented
- **Virtual address space:** set of virtual addresses
- **Physical address space:** set of physical addresses

Paging

- New Idea: split virtual address space into multiple fixed size partitions
 - ◆ Each can go anywhere!

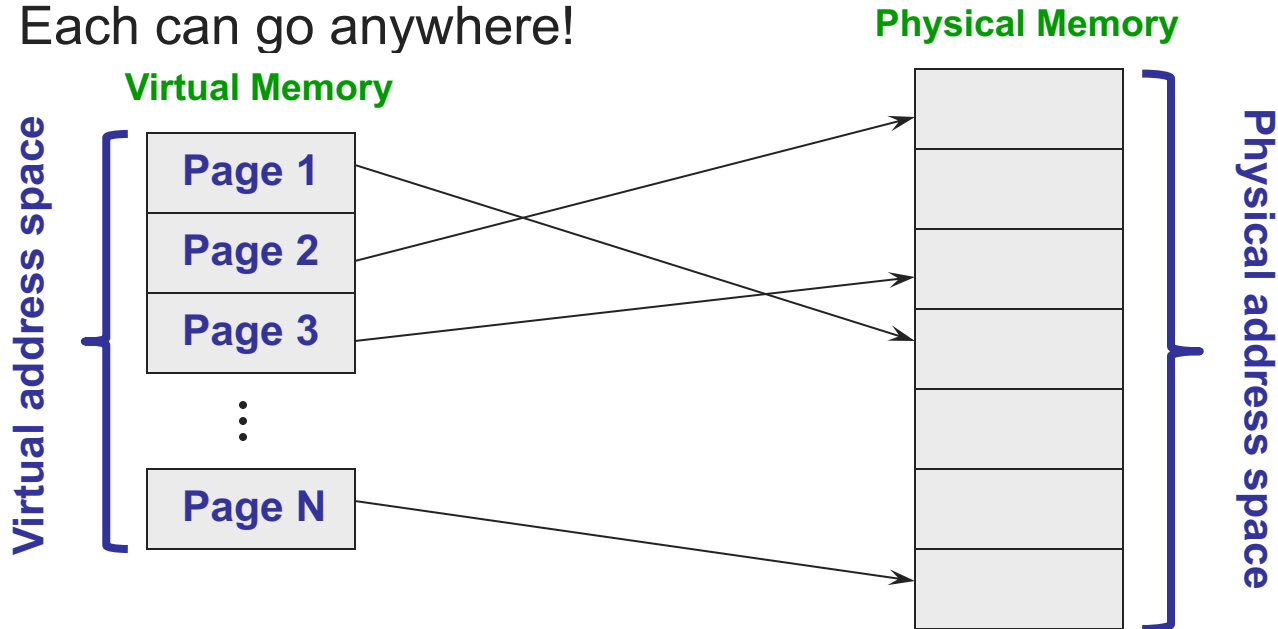

Paging solves the external fragmentation problem by using fixed sized units in both physical and virtual memory

But need to keep track of where things are!

Process Perspective

- Processes view memory as one contiguous address space from 0 through N
 - ◆ Virtual address space (VAS)
- In reality, pages are scattered throughout physical storage
- The mapping is invisible to the program
- Protection is provided because a program cannot reference memory outside of its VAS
 - ◆ The address “0x1000” maps to different physical addresses in different processes

Paging

- Translating addresses
 - ◆ Virtual address has two parts: **virtual page number** and **offset**
 - ◆ Virtual page number (VPN) is an index into a page table
 - ◆ Page table determines page frame number (PFN)
 - ◆ Physical address is PFN::offset
- Page tables
 - ◆ Map **virtual page number** (VPN) to **page frame number** (PFN)
 - » VPN is the index into the table that determines PFN
 - ◆ One page table entry (PTE) per page in virtual address space
 - » Or, one PTE per VPN

Page Lookups

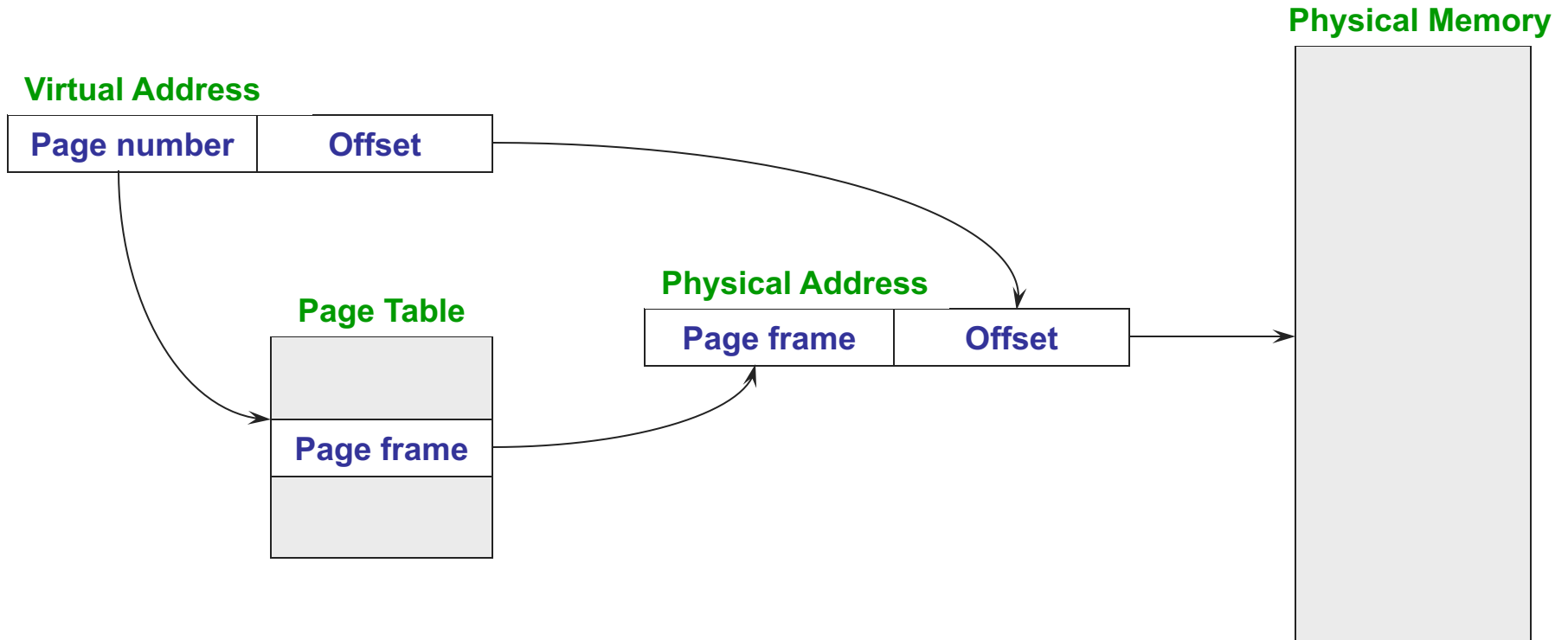

Paging Example

- Pages are 4KB
 - ◆ Offset is 12 bits (because $4\text{KB} = 2^{12}$ bytes)
 - ◆ VPN is 20 bits (32 bits is the length of every virtual address)
- Virtual address is 0x7468
 - ◆ Virtual page is 0x7, offset is 0x468
- Page table entry 0x7 contains 0x2
 - ◆ Page frame number is 0x2
 - ◆ Seventh virtual page is at address 0x2000 (2nd physical page)
- Physical address = $0x2000 + 0x468 = 0x2468$

Page Table Entries (PTEs)



- Page table entries control mapping
 - ◆ The **Modify** bit says whether or not the page has been written
 - » It is set when a write to the page occurs (**for caching**)
 - ◆ The **Reference** bit says whether the page has been accessed
 - » It is set when a read or write to the page occurs (**for eviction**)
 - ◆ The **Valid** bit says whether or not the PTE can be used
 - » It is checked each time the virtual address is used (**Why?**)
 - ◆ The **Protection** bits say what operations are allowed on page
 - » Read, write, execute (**Why do we need these?**)
 - ◆ The **page frame number** (PFN) determines physical page

Paging

- New Idea: split virtual address space into multiple fixed size partitions
 - ◆ Each can go anywhere!

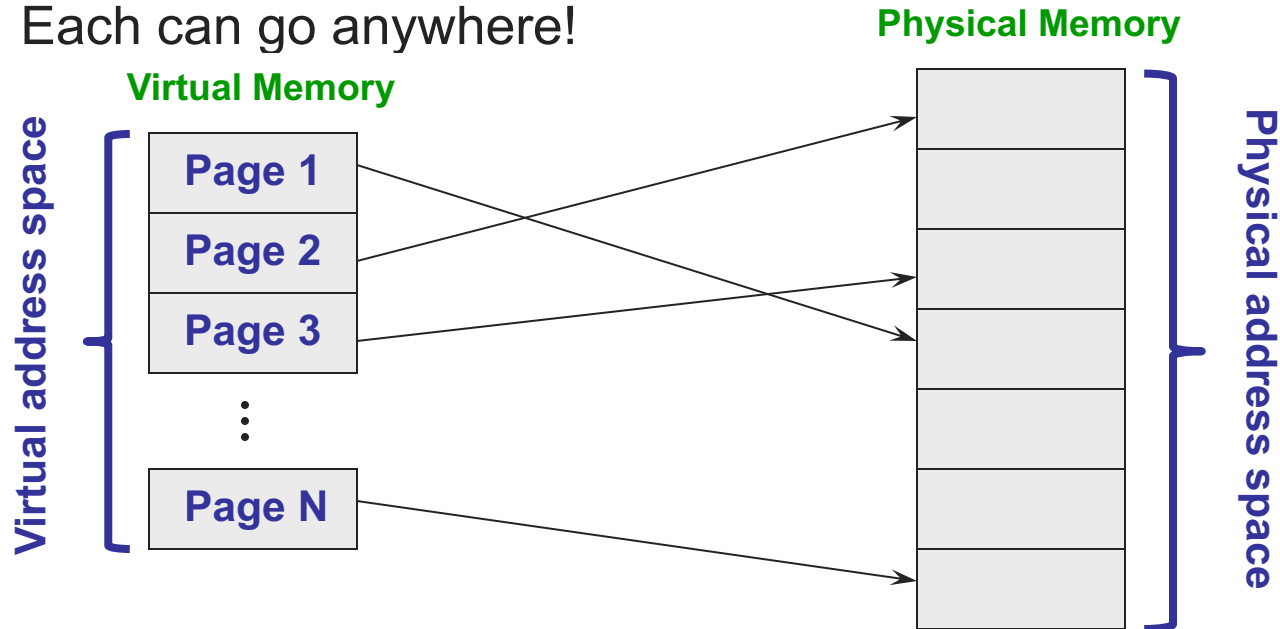

Paging solves the external fragmentation problem by using fixed sized units in both physical and virtual memory

But need to keep track of where things are!

Address Translation With a Page Table

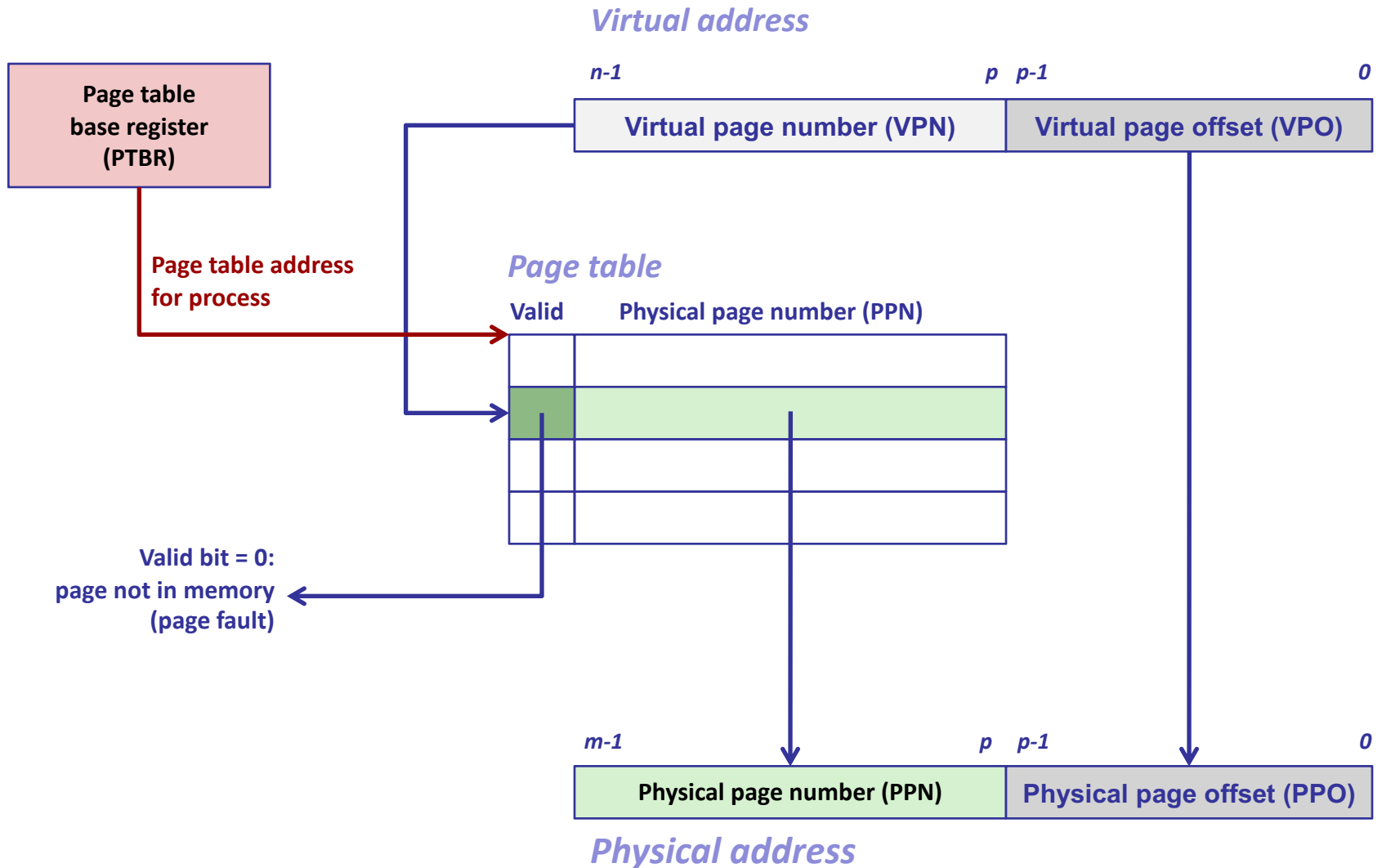

Paging Advantages

- Easy to allocate memory
 - ◆ Memory comes from a free list of fixed size chunks
 - ◆ Allocating a page is just removing it from the list
 - ◆ External fragmentation not a problem
 - » All pages of the same size
- Simplifies protection
 - ◆ All chunks are the same size
 - ◆ Like fixed partitions, don't need a limit register
- Simplifies virtual memory – later

Paging Limitations

- Can still have internal fragmentation
 - ◆ Process may not use memory in multiples of a page
- Memory reference overhead
 - ◆ 2 references per address lookup (page table, then memory)
 - ◆ What can we do?
- Memory required to hold page table can be significant
 - ◆ Need one PTE per page
 - ◆ 32-bit address space w/ 4KB pages = 2^{20} PTEs
 - ◆ 4 bytes/PTE = 4MB/page table
 - ◆ 25 processes = 100MB just for page tables!
 - ◆ What can we do?

Managing Page Tables

- Last lecture we computed the size of the page table for a 32-bit address space w/ 4K pages to be 4MB
 - ◆ This is far too much overhead for each process
- How can we reduce this overhead?
 - ◆ Observation: process don't use all the addresses, so we only need to map the portion of the address space this is actually being used (tiny fraction of entire address space)
- How do we only map what is being used?
 - ◆ Can dynamically extend page table
- Use another level of indirection: two-level page tables

Two-Level Page Tables

- Two-level page tables
 - ◆ Each virtual address (VA) has three parts:
 - » Master page number, secondary page number, and offset

Master page number	Secondary	Offset
--------------------	-----------	--------

- ◆ Master page table maps VA to secondary page table
- ◆ Secondary page table maps virtual page number to physical page
- ◆ Offset indicates where in physical page address is located

One-Level Page Lookups

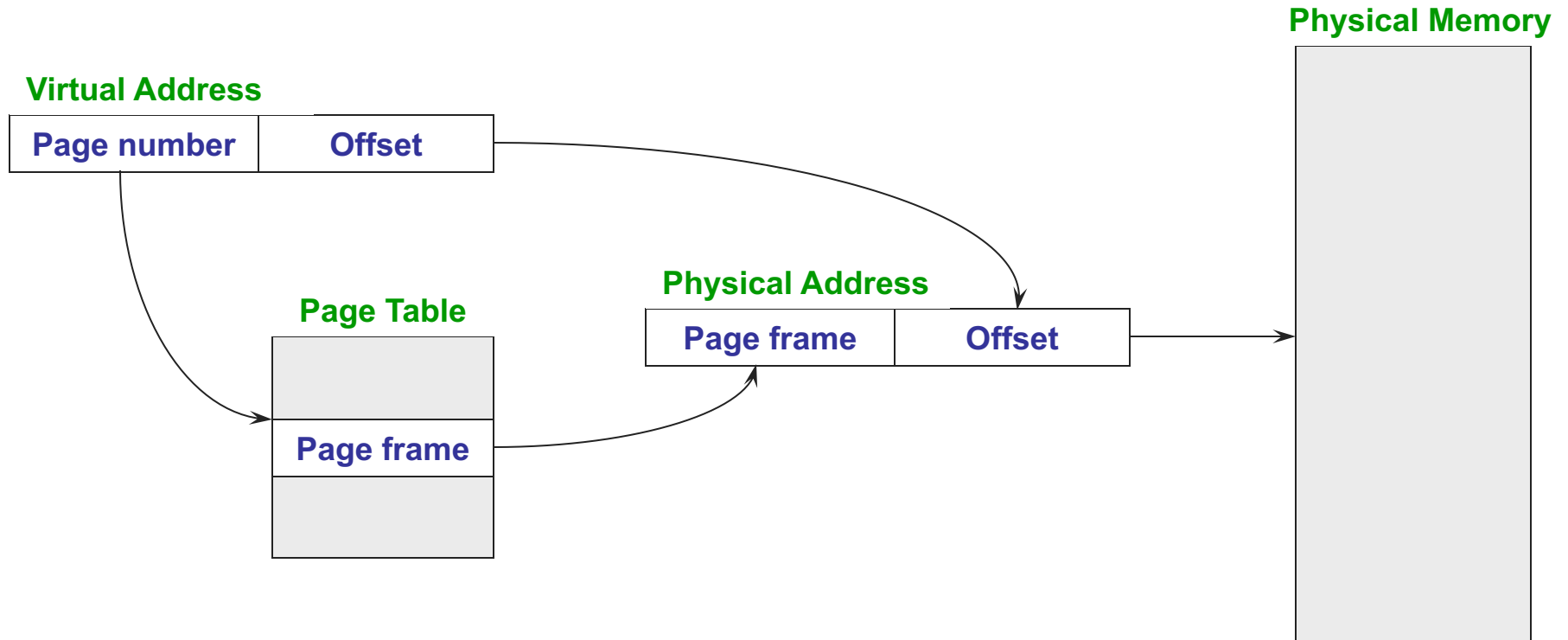

Two-Level Page Lookups

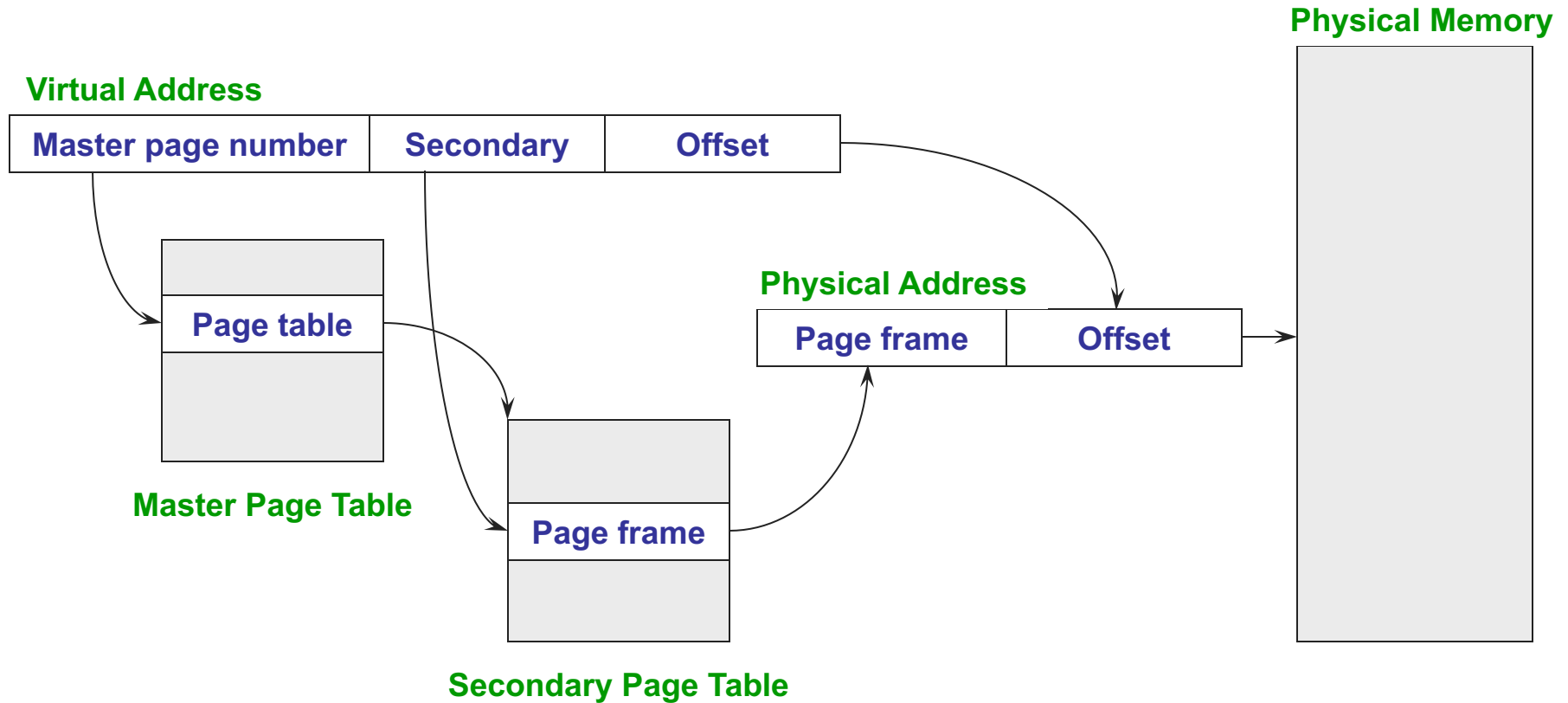

Example

- How many bits in offset? $4K = 12$ bits
- 4KB pages, 4 bytes/PTE
- Want master page table in one page: $4K/4$ bytes = 1K entries
- Hence, 1K secondary page tables
- How many bits?
 - ◆ Master page number = 10 bits (because 1K entries)
 - ◆ Offset = 12 bits
 - ◆ Secondary page number = $32 - 10 - 12 = 10$ bits

A Two-Level Page Table Hierarchy

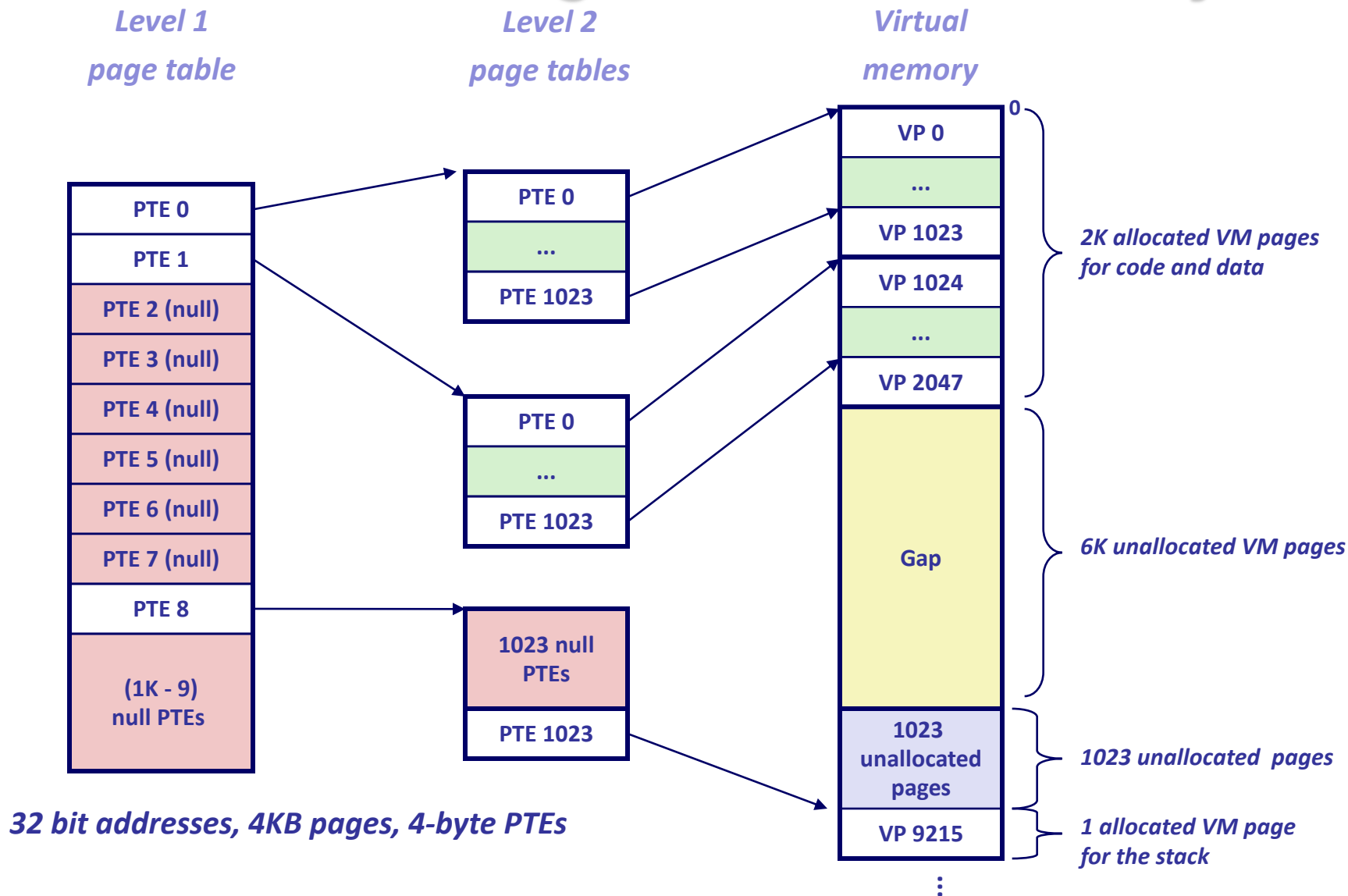

Intel IA32-e Paging

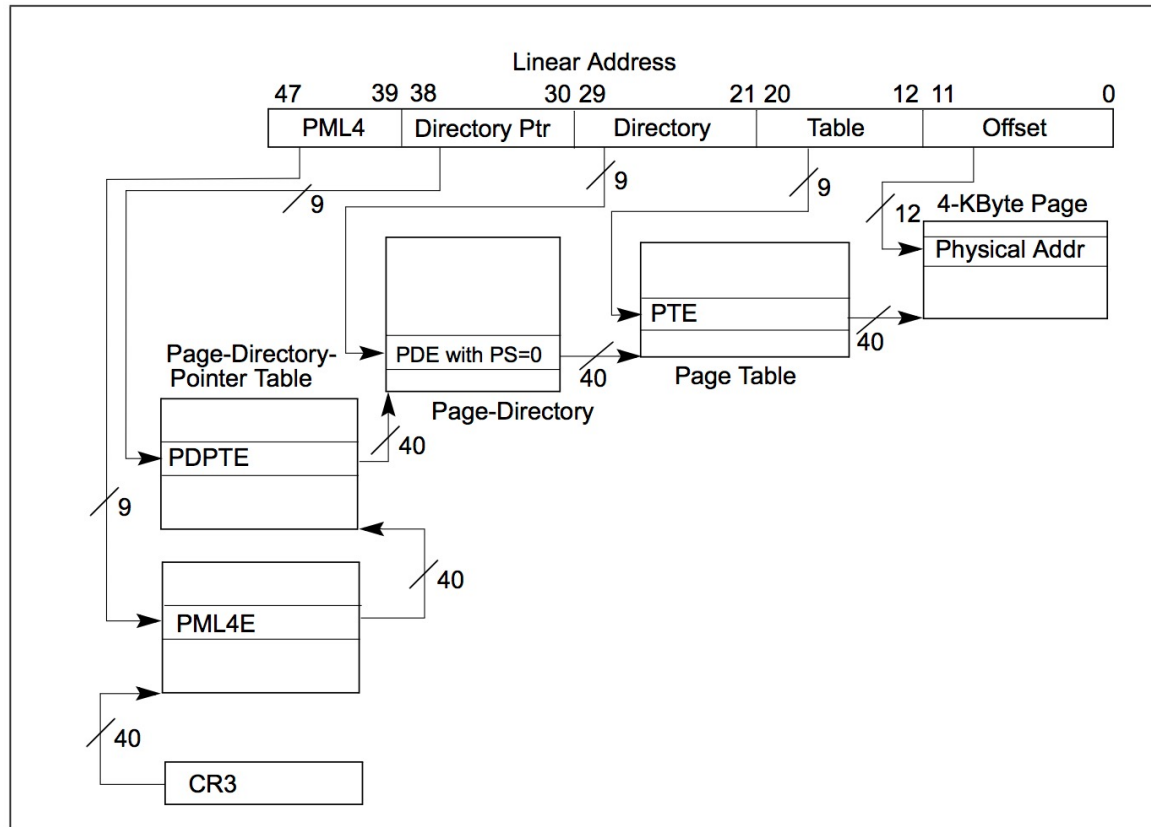

Figure 4-8. Linear-Address Translation to a 4-KByte Page using IA-32e Paging

Multi-level Paging

- Multi-level paging reduces memory overhead of paging
 - ◆ Only need one master page table and one secondary page table when a process begins
 - ◆ As address space grows, allocate more secondary page tables and add PTEs to master page table
- What problem remains?
 - ◆ Hint: what about memory lookups?

Efficient Translations

- Recall that our original page table scheme doubled the latency of doing memory lookups
 - ◆ One lookup into the page table, another to fetch the data
- Now two-level page tables triple the latency!
 - ◆ Two lookups into the page tables, a third to fetch the data
 - ◆ And this assumes the page table is in memory
- How can we use paging but also have lookups cost about the same as fetching from memory?
 - ◆ Cache (remember) translations in hardware
 - ◆ Translation Lookaside Buffer (TLB)
 - ◆ TLB managed by Memory Management Unit (MMU)